

HD82 - Aluminium Folding Sliding Door System General Arrangement Drawings - Outward Opening

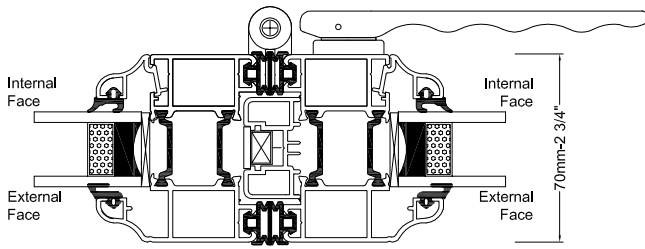

Section 5:
Locking folding panels, with Flat Handle

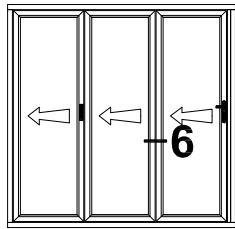
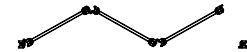
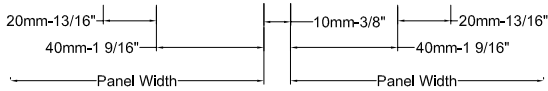
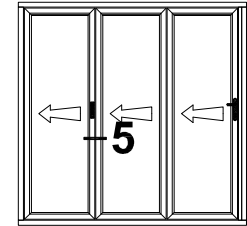

Section 6:
Non-locking folding panels and roller assembly

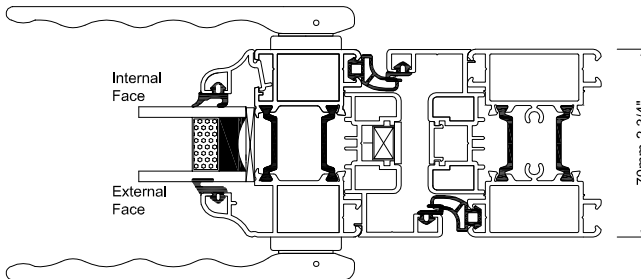
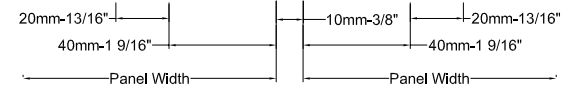
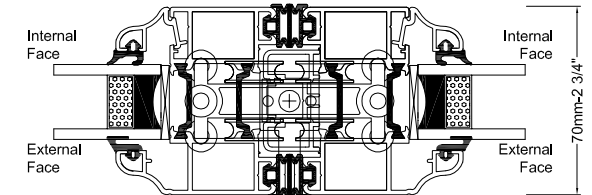

Section 7:
Swing panel and jamb with closing rebates

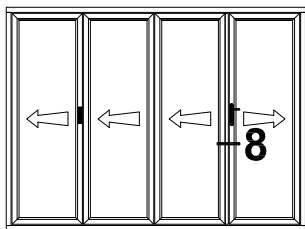
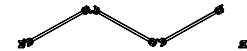
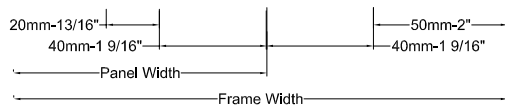
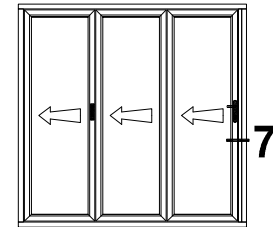

Section 8:
Swing panel and slave panel with closing rebates

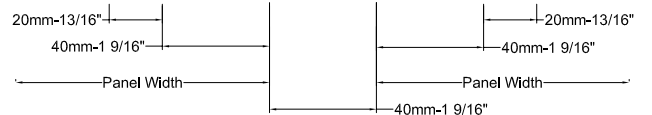
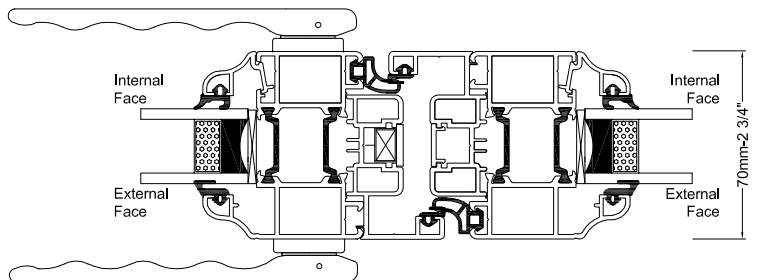
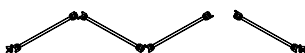

HD82 - Aluminium Folding Sliding Door System

General Arrangement Drawings - Outward Opening

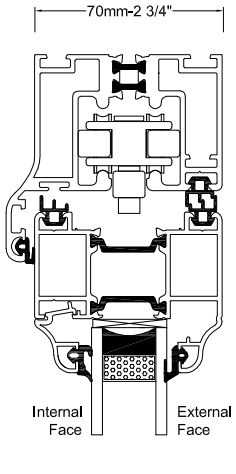

Section 1:
Top Track

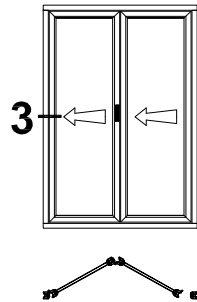
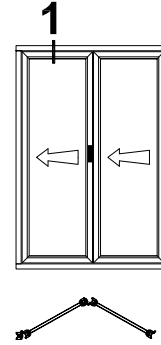

Section 3:
Jamb

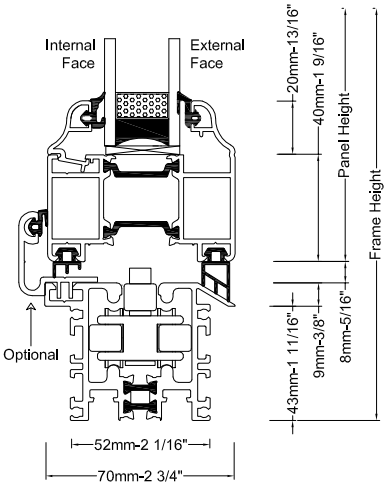
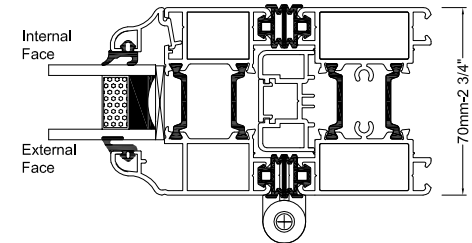

Section 2:
Bottom Track

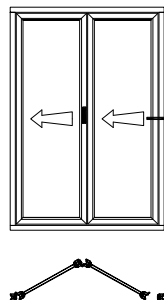
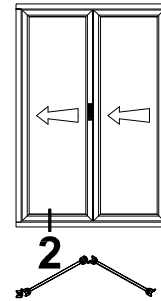

Section 4:
Jamb with Roller Assembly

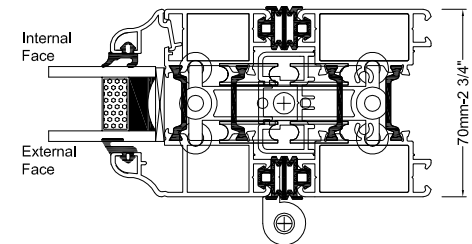

HD82 - Aluminium Folding Sliding Door System

General Arrangement Drawings - Outward Opening

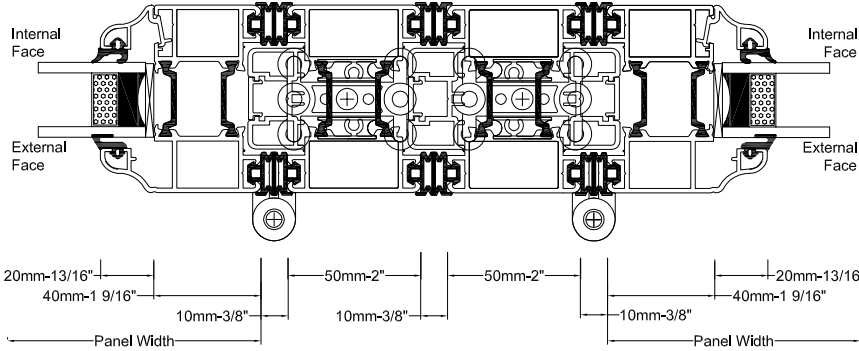

Section 9:
Meeting sliding mullions with
roller assemblies

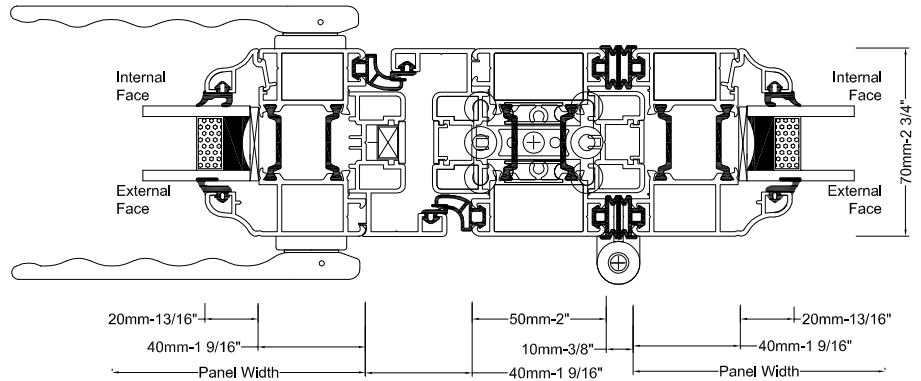
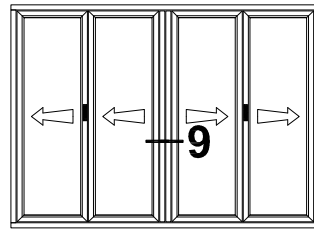

Section 10:
Sliding mullion and swing panel
with closing rebates and roller
assembly

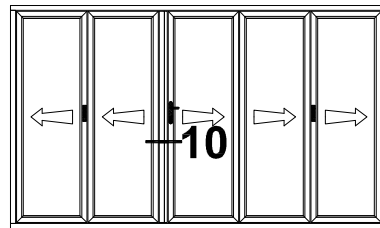

HD82 - Aluminium Folding Sliding Door System

General Arrangement Drawings - Outward Opening

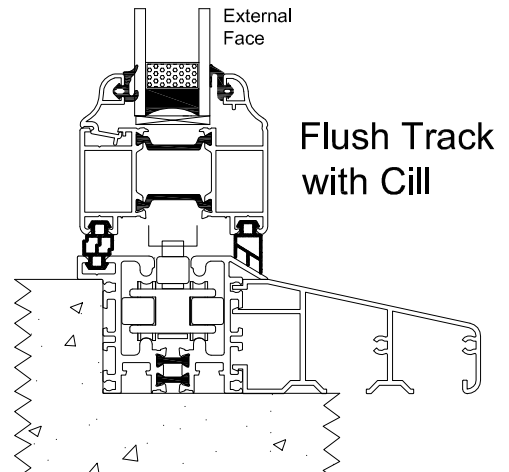
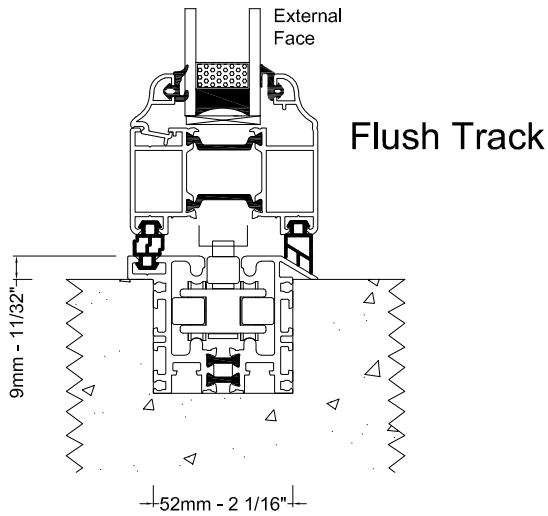
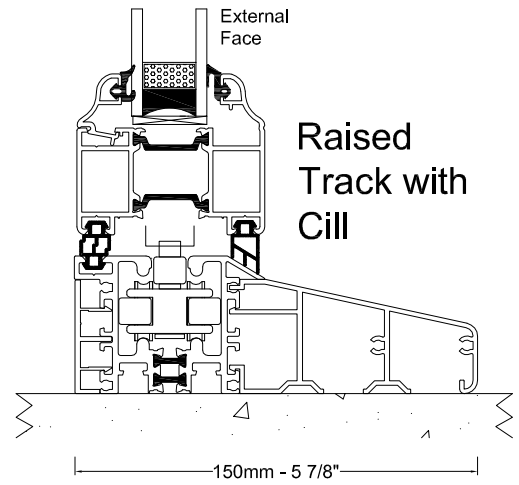
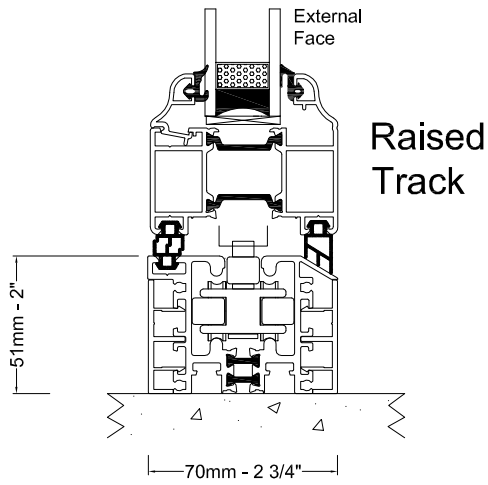

Optional threshold rebate available for all threshold types

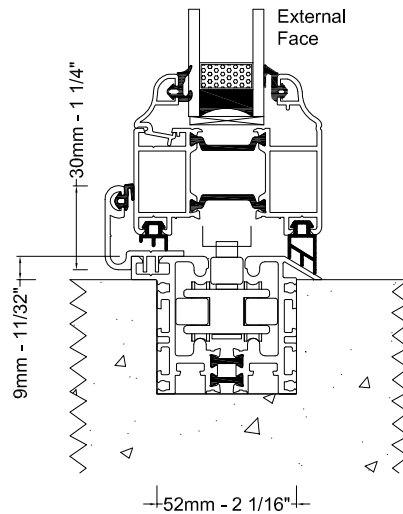

HD82 - Aluminium Folding Sliding Door System

General Arrangement Drawings - Inward Opening

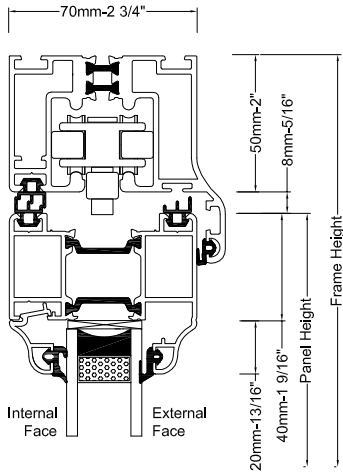

Section 1:
Top Track

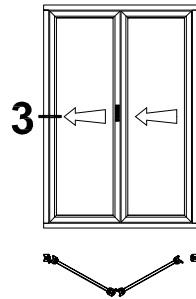
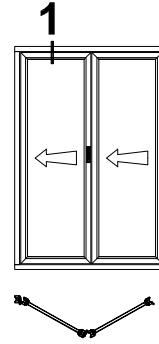

Section 3:
Jamb

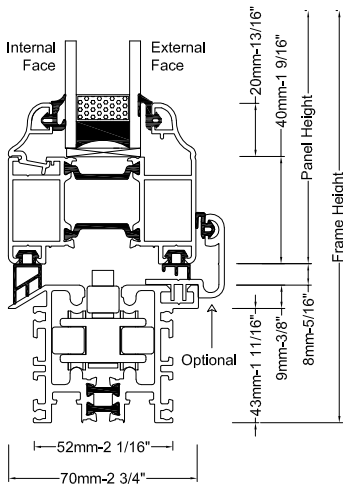
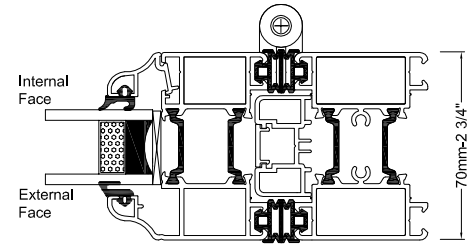

Section 2:
Bottom Track

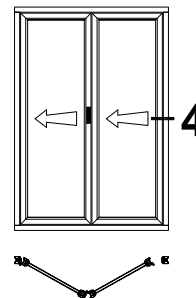
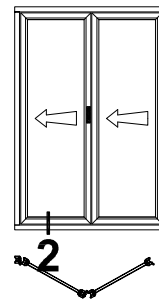
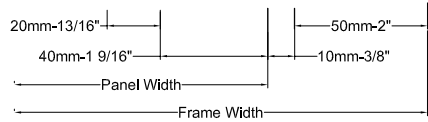

Section 4:
Jamb with Roller Assembly

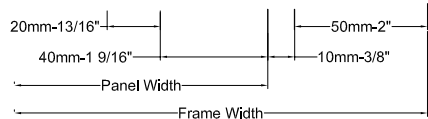
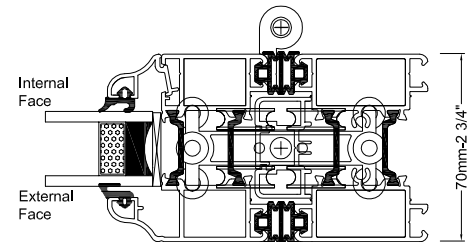

HD82 - Aluminium Folding Sliding Door System General Arrangement Drawings - Inward Opening

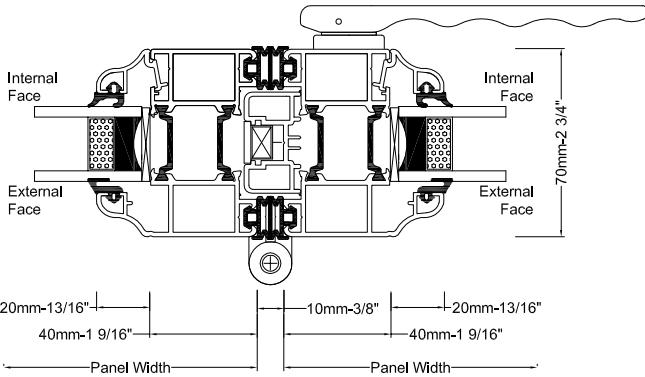

Section 5:
Locking folding panels, with Flat Handle

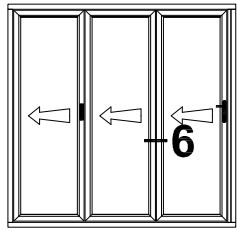
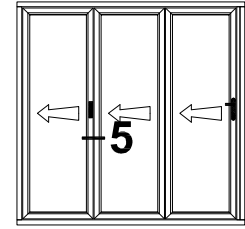

Section 6:
Non-locking folding panels and roller assembly

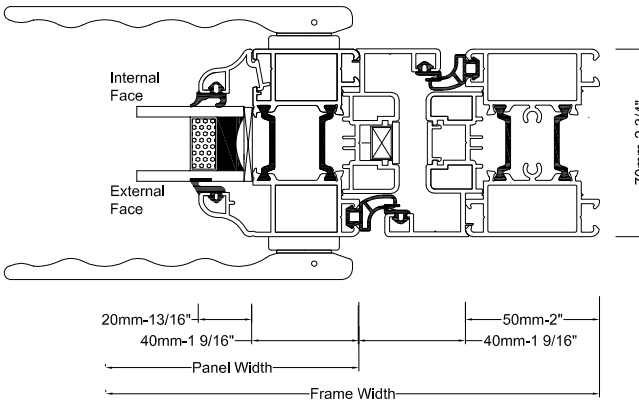
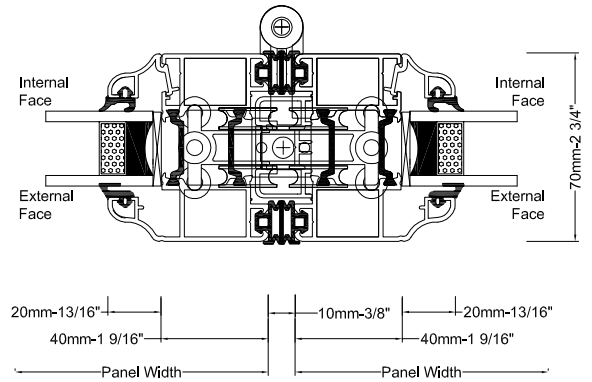

Section 7:
Swing panel and jamb with closing rebates

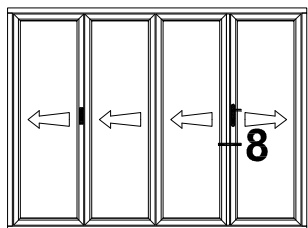
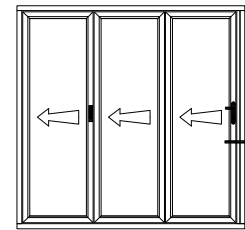

Section 8:
Swing panel and slave panel with closing rebates

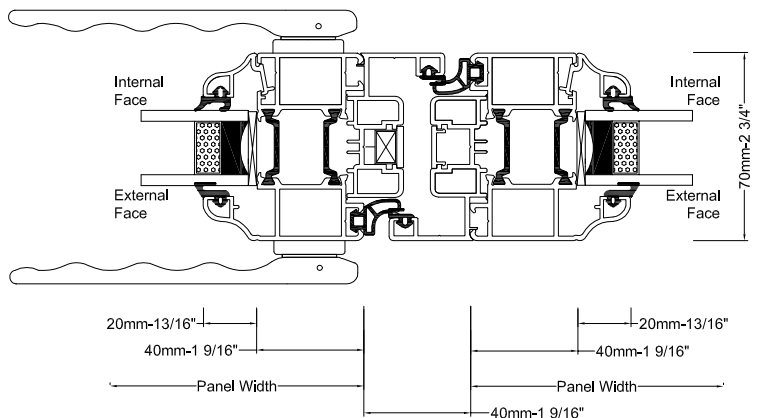

HD82 - Aluminium Folding Sliding Door System

General Arrangement Drawings - Inward Opening

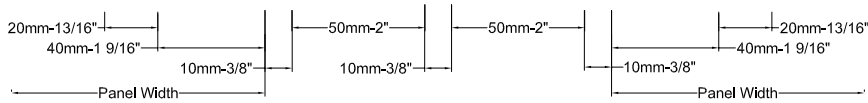
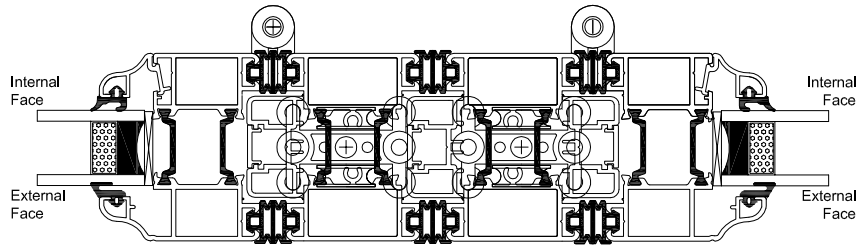

Section 9:
Meeting sliding mullions with
roller assemblies

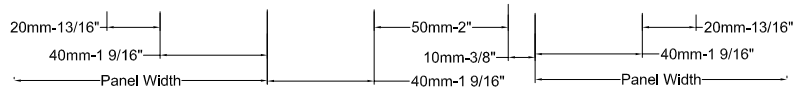
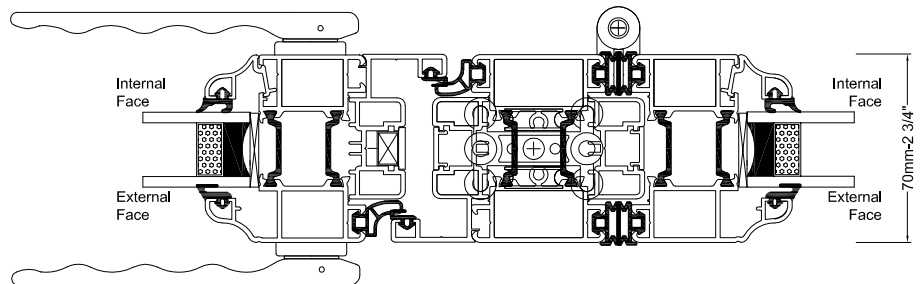
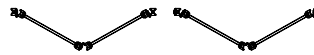
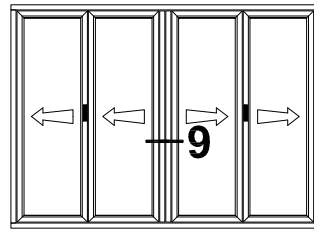

Section 10:
Sliding mullion and swing panel
with closing rebates and roller
assembly

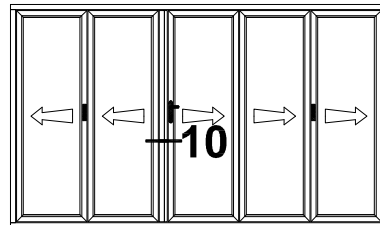

HD82 - Aluminium Folding Sliding Door System

General Arrangement Drawings - Inward Opening

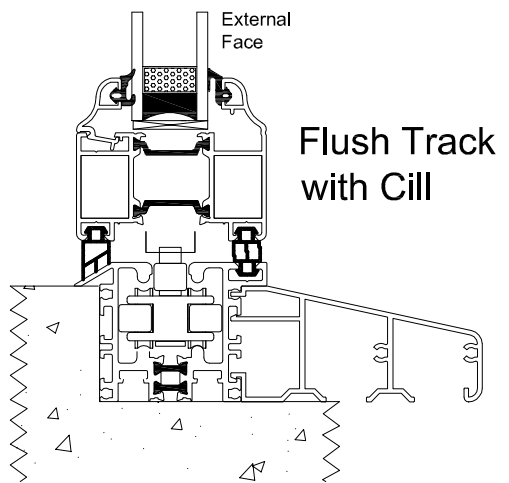
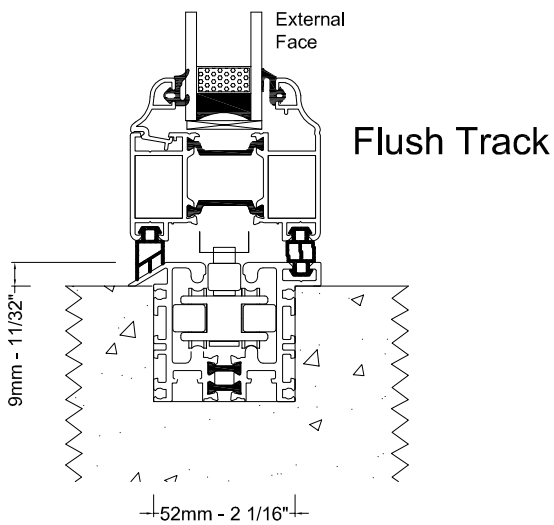
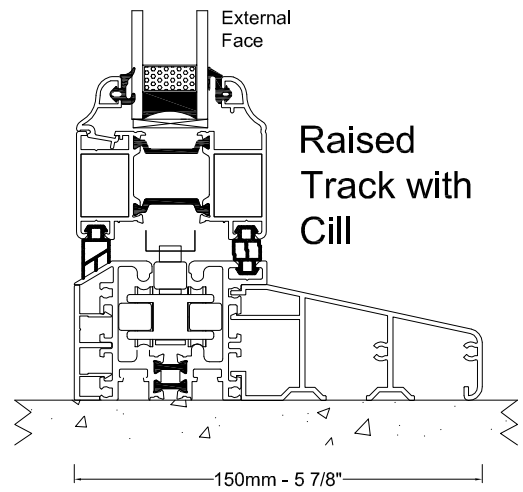
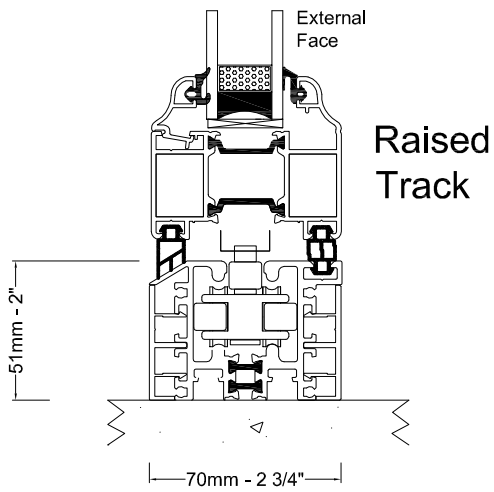

Optional threshold rebate available for all threshold types

