

Section 5:
Locking folding panels, with Flat Handle

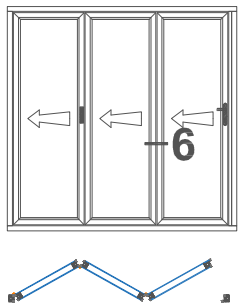

Section 6:
Non-locking folding panels and roller assembly

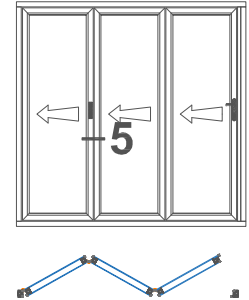
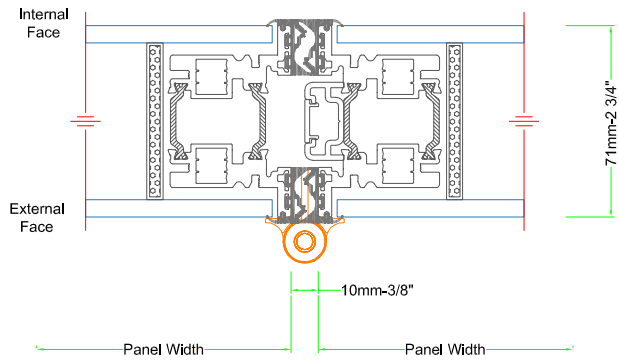

Section 7:
Swing panel and jamb with closing rebates

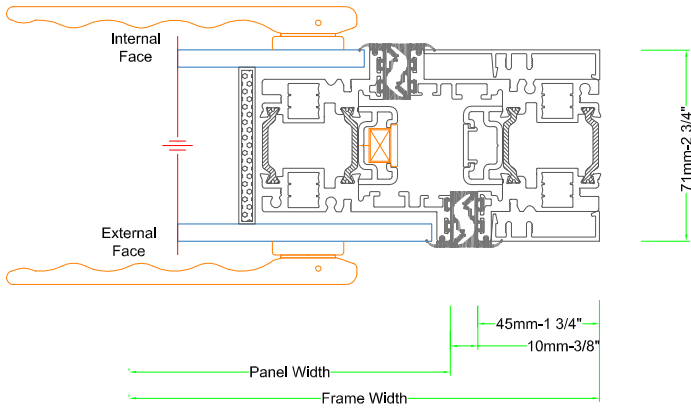
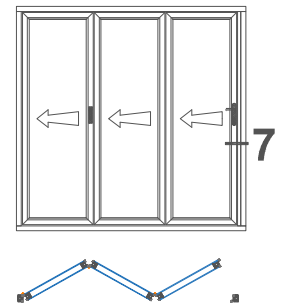

Section 8:
Swing panel and slave panel with closing rebates

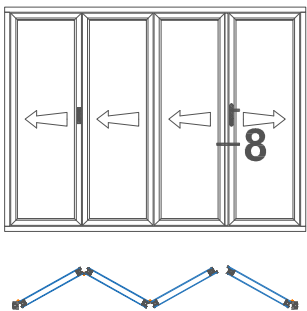
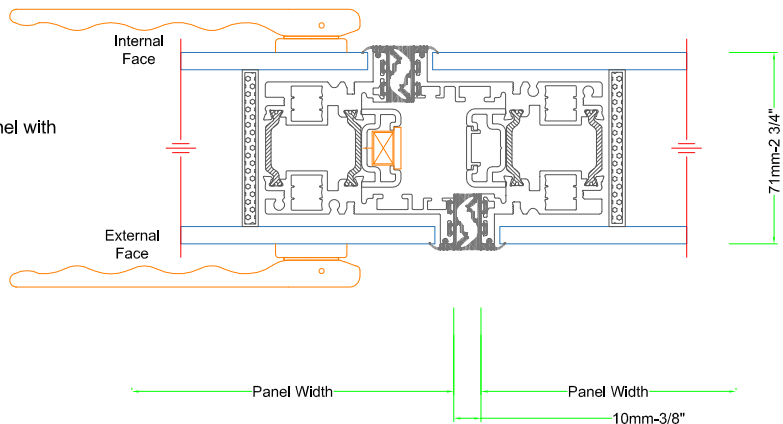

GG65 - Dual Sided GlassEdge Folding Sliding Door System

General Arrangement Drawings - Outward Opening

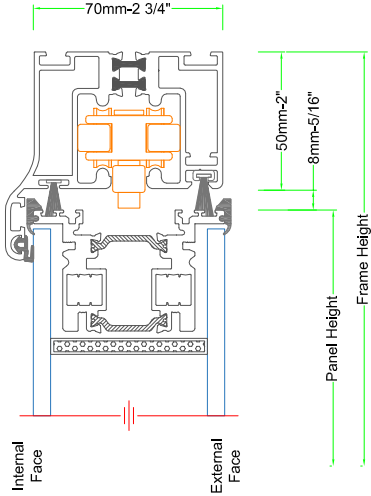

Section 1:
Top Track

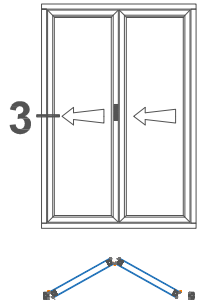
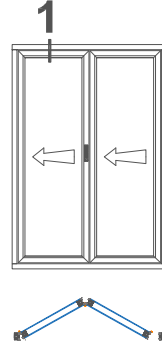

Section 3:
Jamb

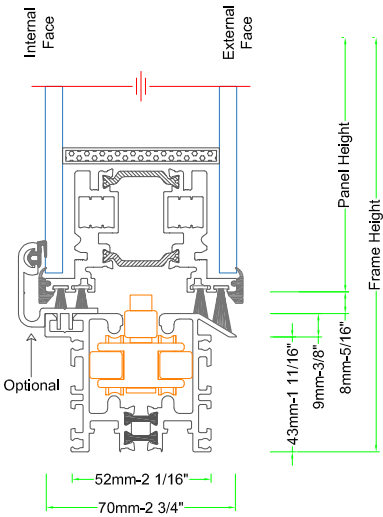
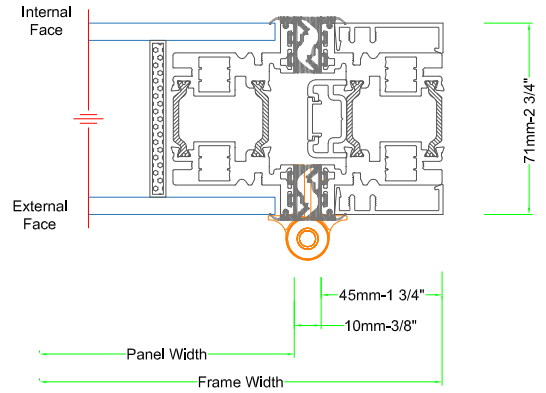

Section 2:
Bottom Track

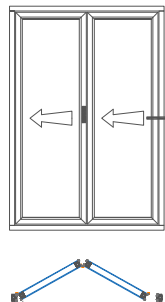
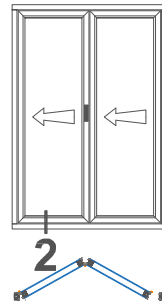

Section 4:
Jamb with Roller Assembly

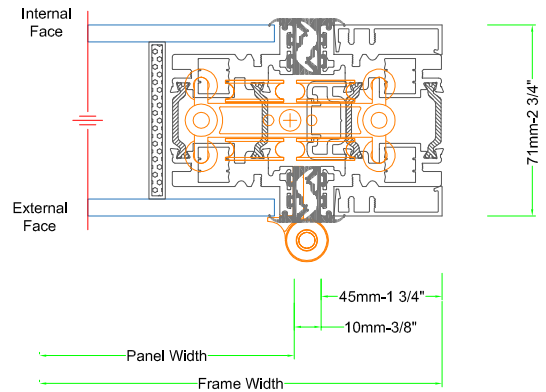

GG65 - Dual Sided GlassEdge Folding Sliding Door System

General Arrangement Drawings - Outward Opening

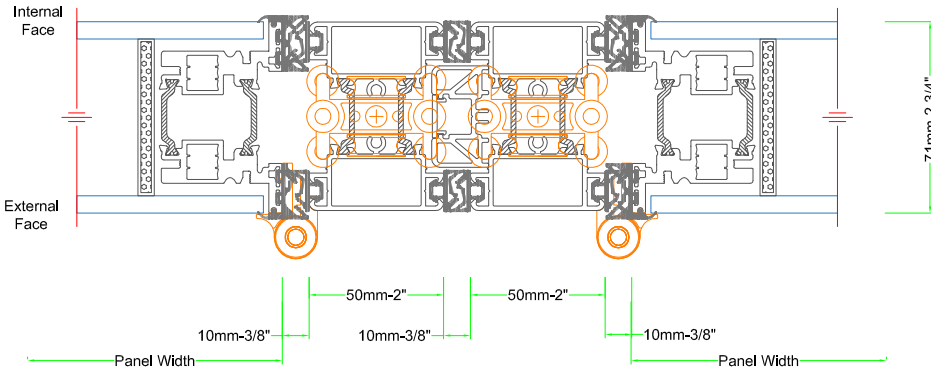

Section 9:
Meeting sliding mullions with roller assemblies

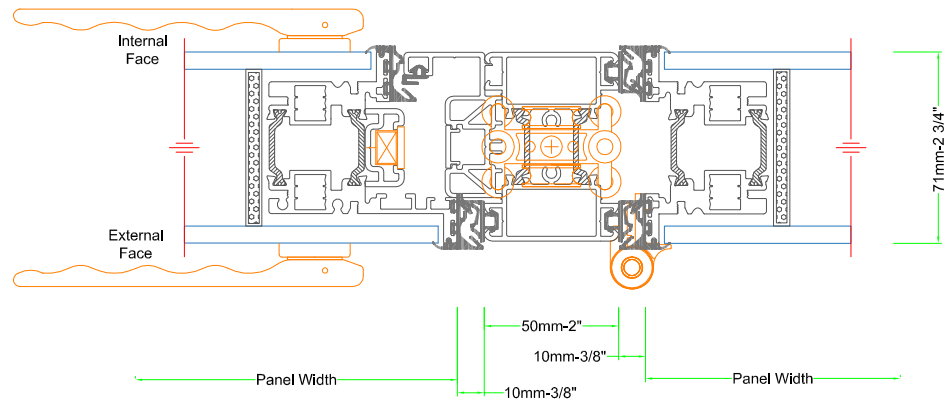
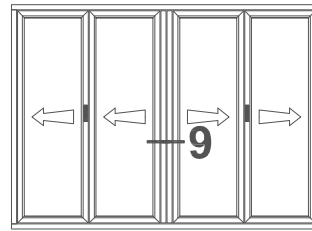

Section 10:
Sliding mullion and swing panel with closing rebates and roller assembly

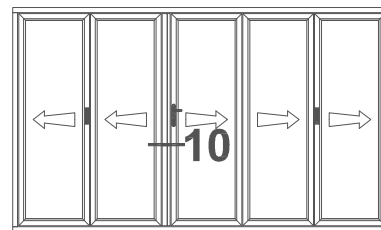

GG65 - Dual Sided GlassEdge Folding Sliding Door System

General Arrangement Drawings - Outward Opening

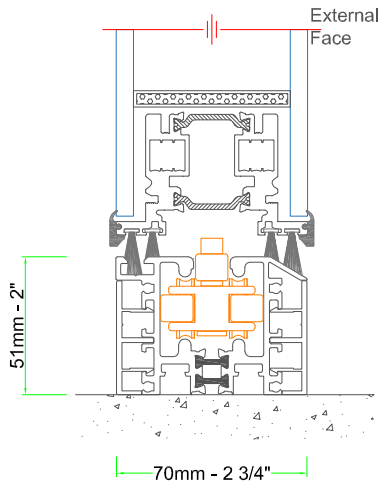

Raised Track

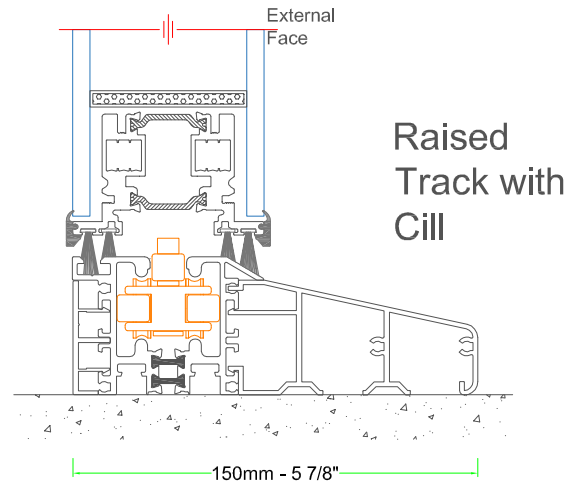

Raised Track with Cill

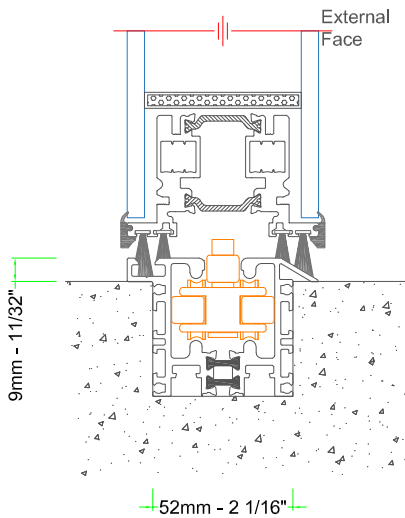

Flush Track

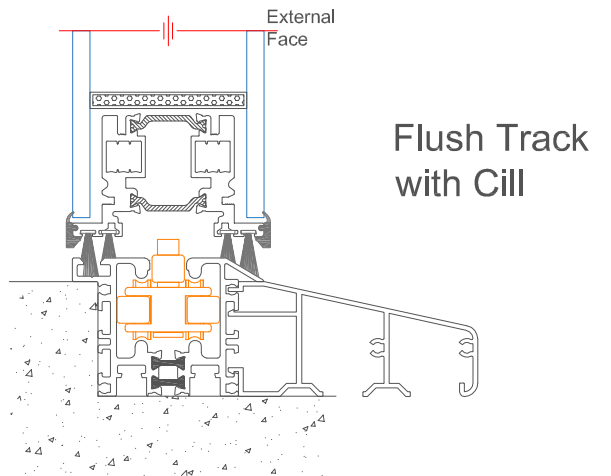

Flush Track with Cill

Optional threshold rebate available for all threshold types

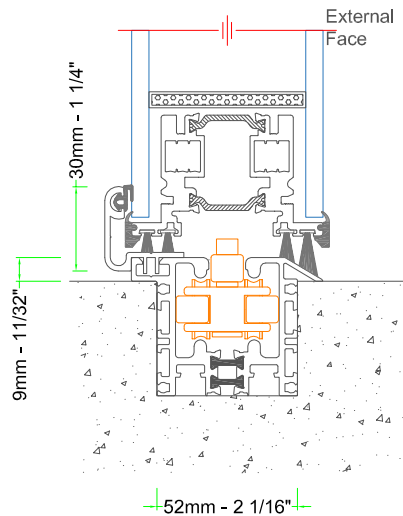

GG65 - Dual Sided GlassEdge Folding Sliding Door System

General Arrangement Drawings - Inward Opening

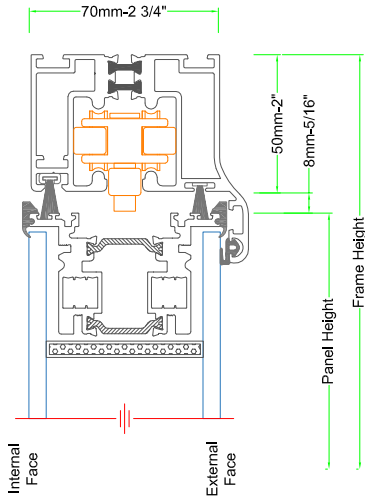

Section 1:
Top Track

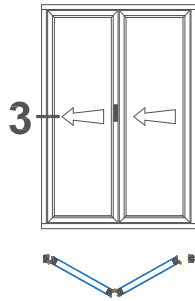
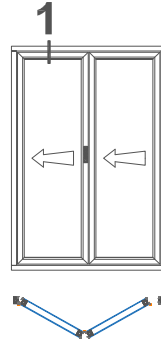

Section 3:
Jamb

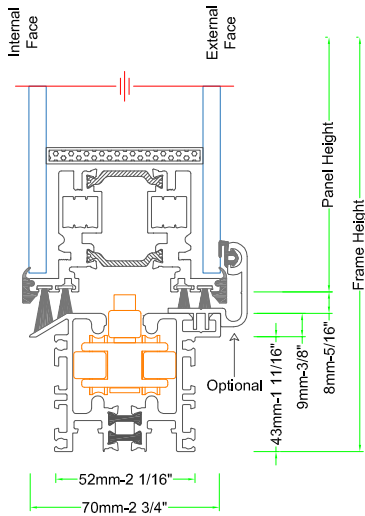
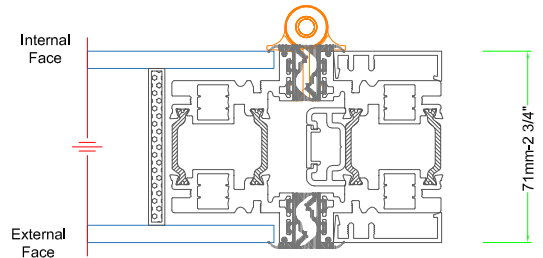

Section 2:
Bottom Track

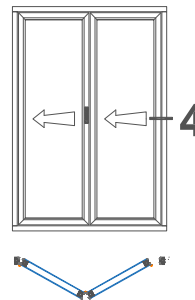
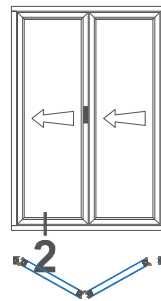

Section 4:
Jamb with Roller Assembly

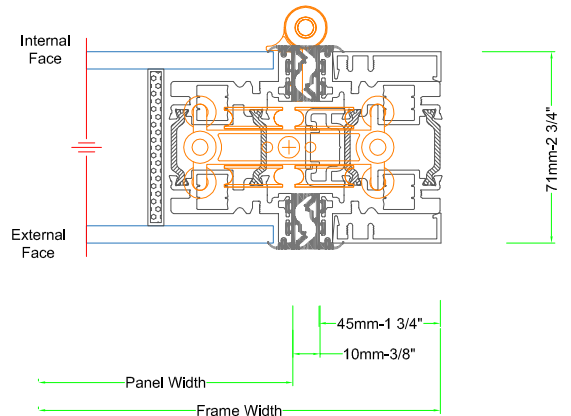
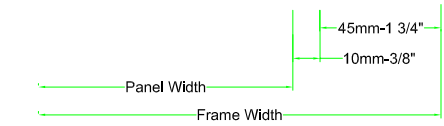

GG65 - Dual Sided GlassEdge Folding Sliding Door System

General Arrangement Drawings - Inward Opening

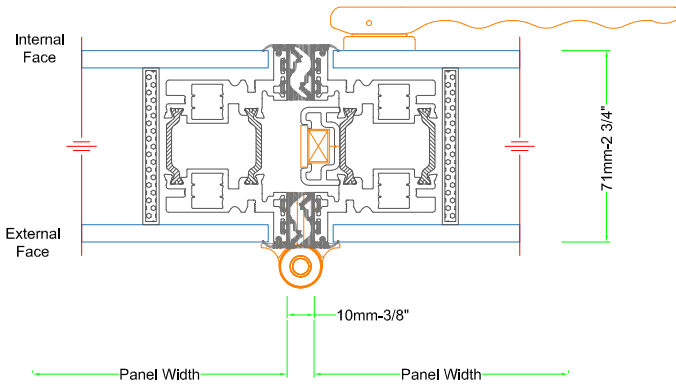

Section 5:
Locking folding panels, with Flat Handle

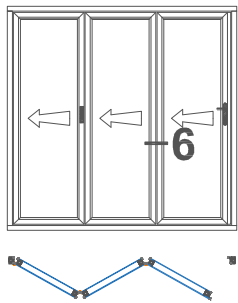
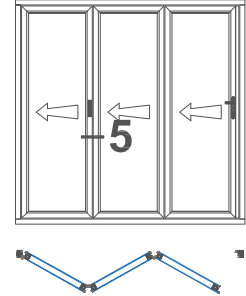

Section 6:
Non-locking folding panels and roller assembly

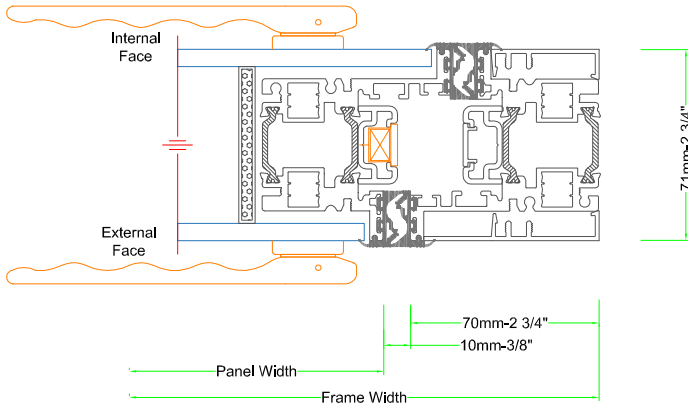
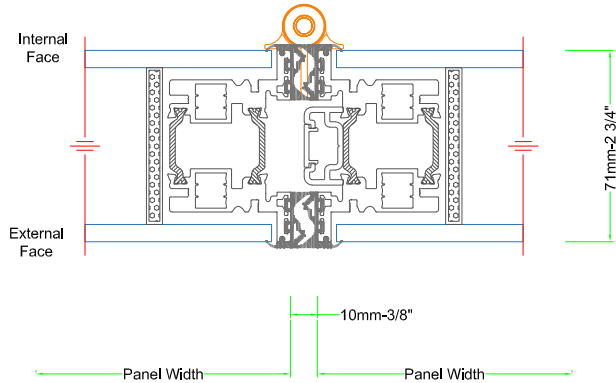

Section 7:
Swing panel and jamb with closing rebates

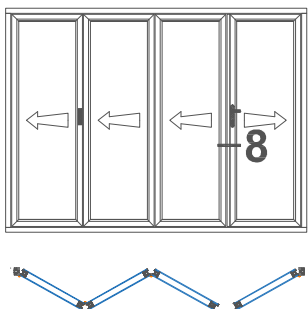
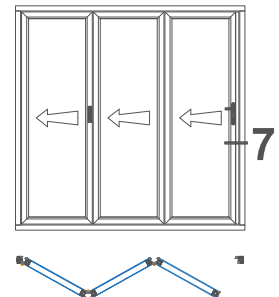

Section 8:
Swing panel and slave panel with closing rebates

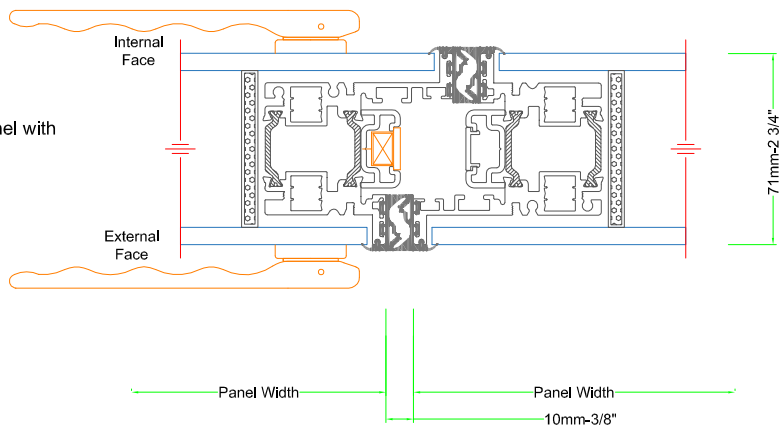

GG65 - Dual Sided GlassEdge Folding Sliding Door System

General Arrangement Drawings - Inward Opening

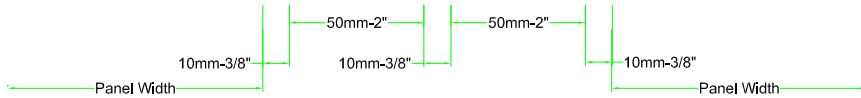
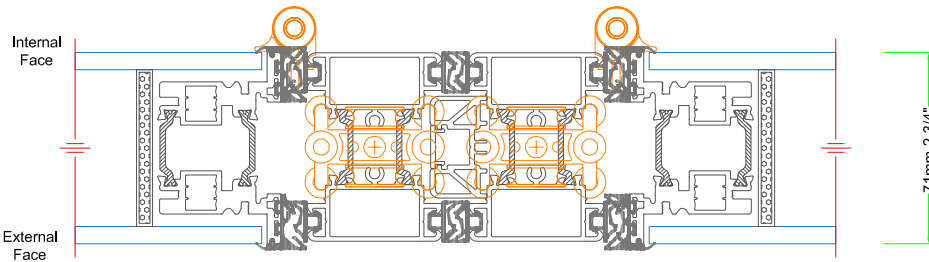

Section 9:
Meeting sliding mullions with roller assemblies

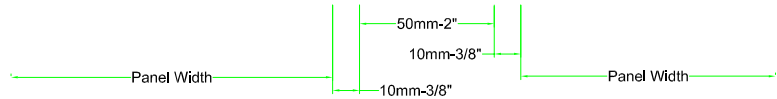
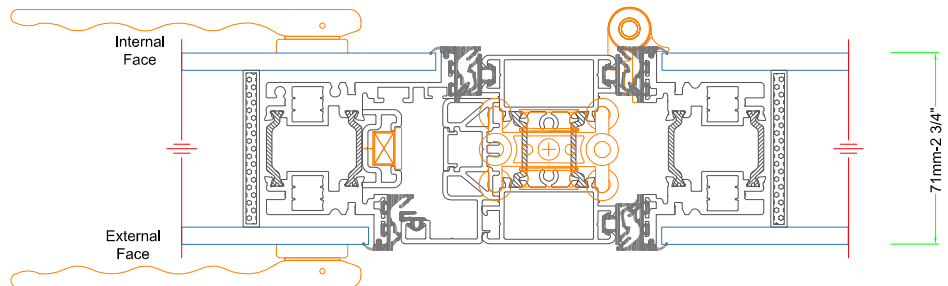
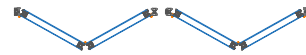
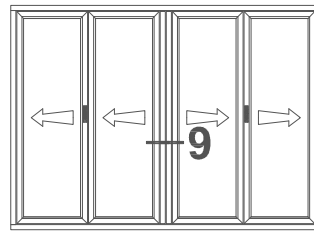

Section 10:
Sliding mullion and swing panel with closing rebates and roller assembly

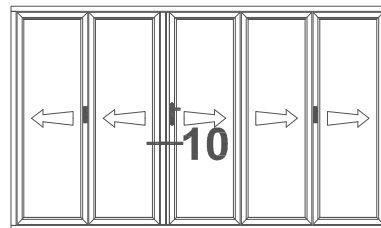

GG65 - Dual Sided GlassEdge Folding Sliding Door System

General Arrangement Drawings - Inward Opening

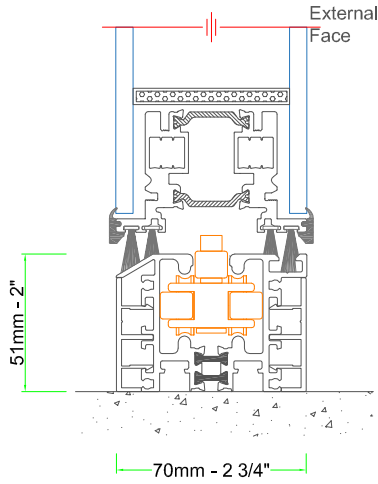

Raised Track

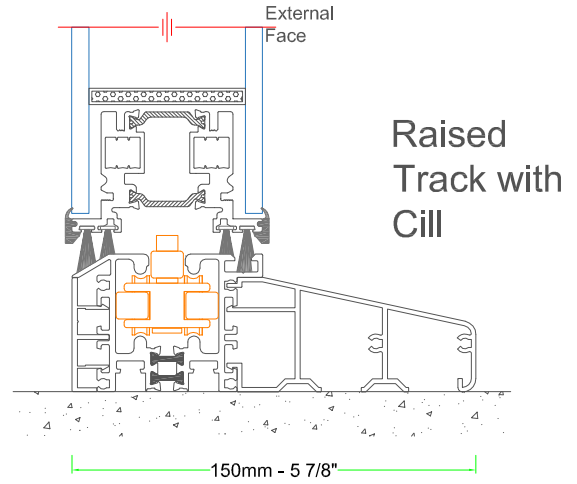

Raised Track with Cill

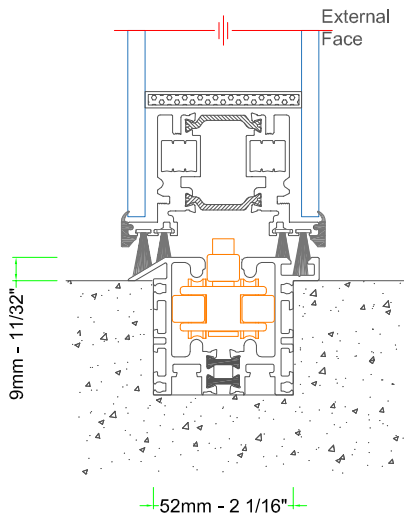

Flush Track

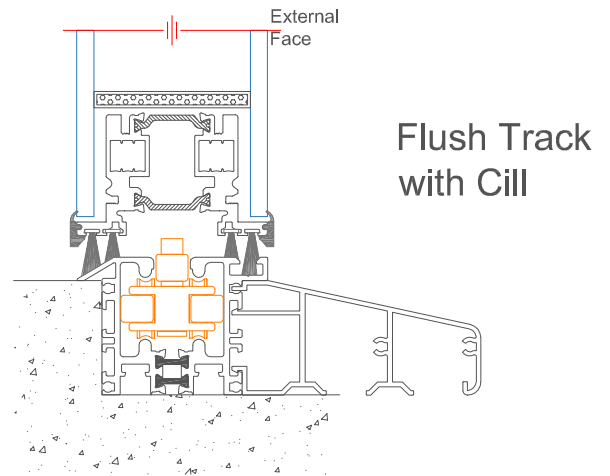

Flush Track with Cill

Optional threshold rebate available for all threshold types

