

Section 1:
Top Track

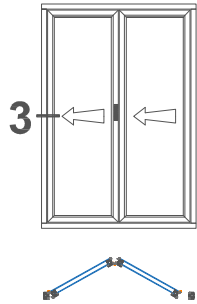

Section 3:
Jamb

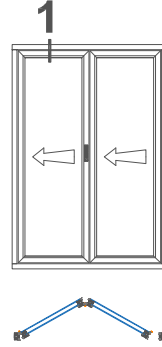
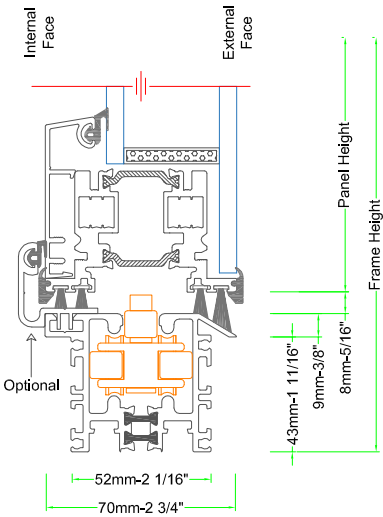
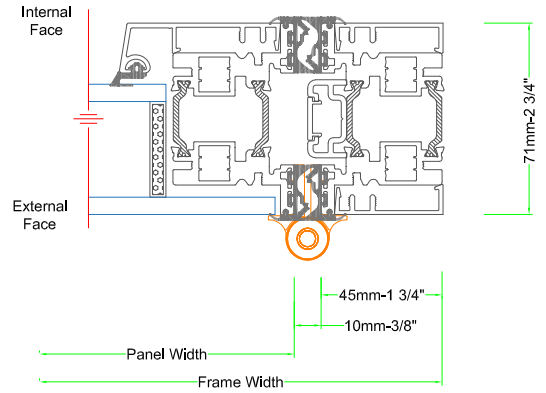

Section 2:
Bottom Track

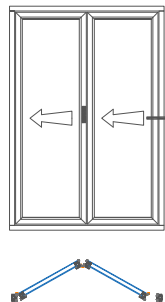
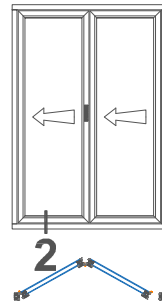

Section 4:
Jamb with Roller Assembly

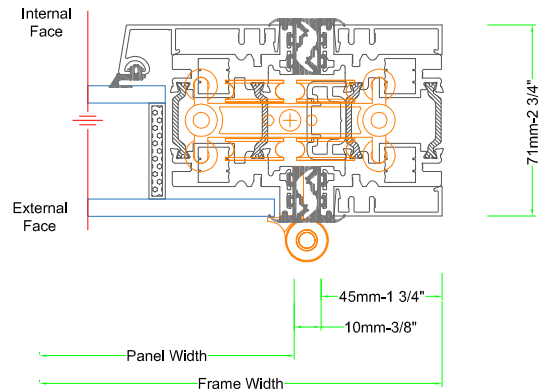

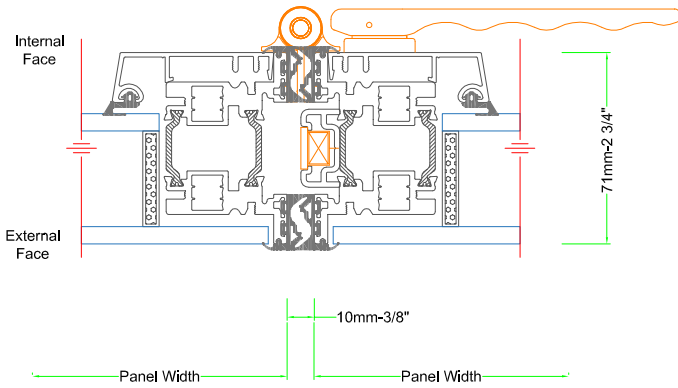

Section 5:
Locking folding panels, with Flat Handle

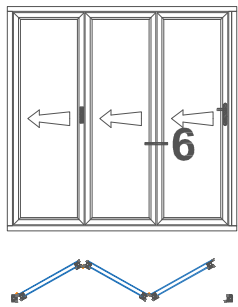
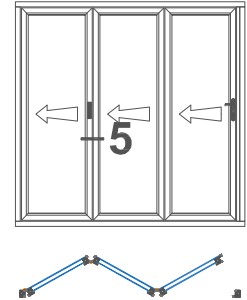

Section 6:
Non-locking folding panels and roller assembly

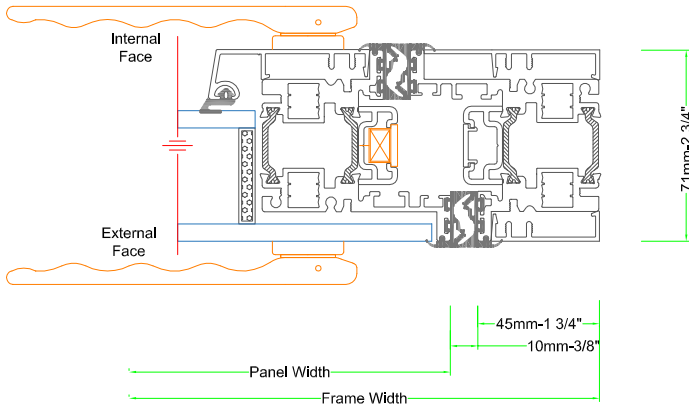
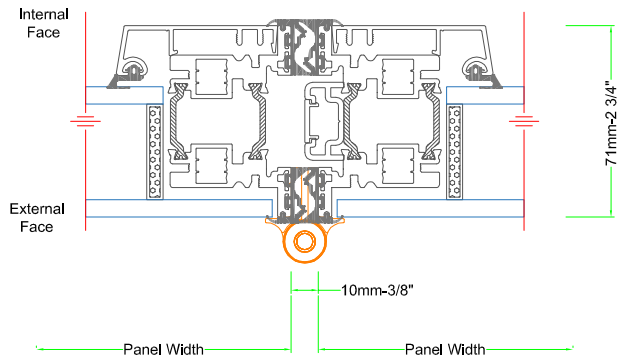

Section 7:
Swing panel and jamb with closing rebates

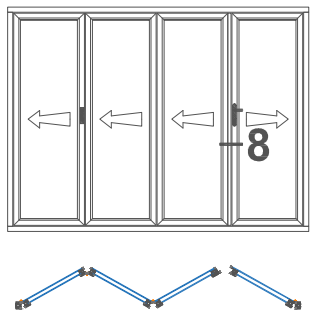
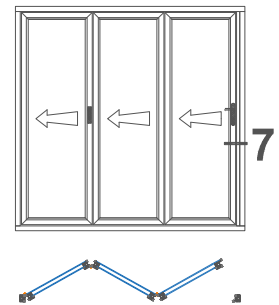

Section 8:
Swing panel and slave panel with closing rebates

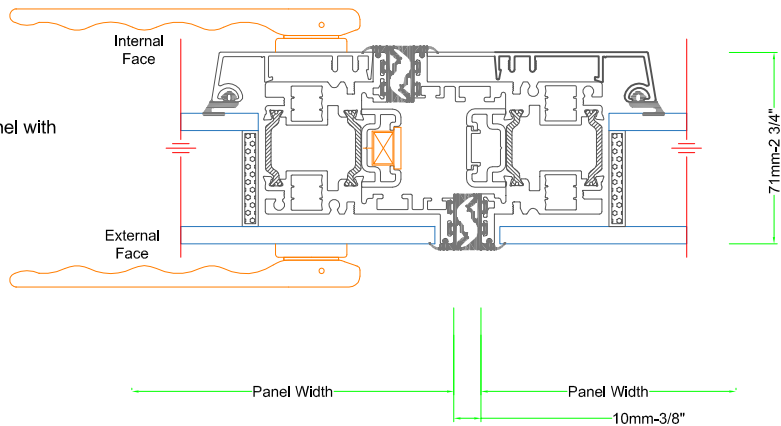

AG65 - Aluminium / Glass/Edge Folding Sliding Door System

General Arrangement Drawings - Outward Opening

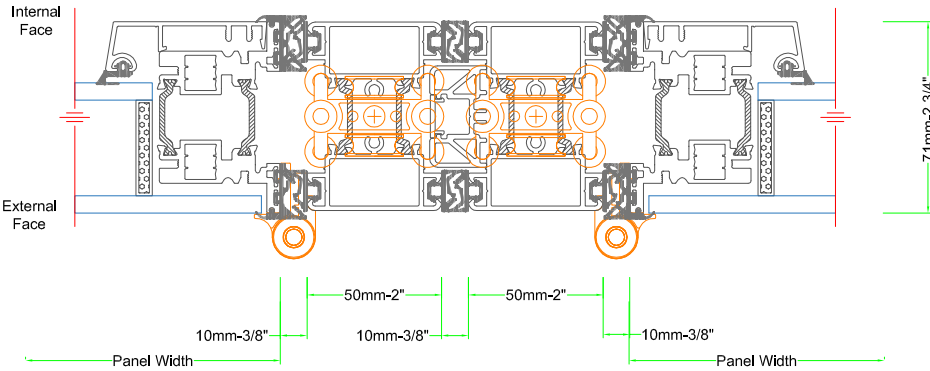

Section 9:
Meeting sliding mullions with roller assemblies

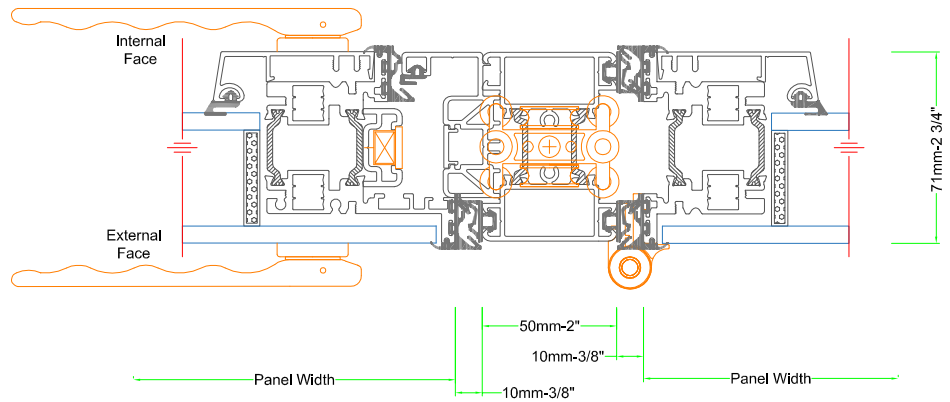
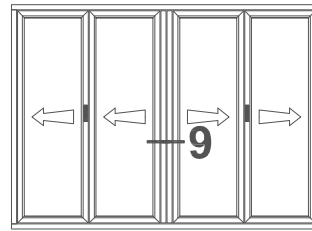

Section 10:
Sliding mullion and swing panel with closing rebates and roller assembly

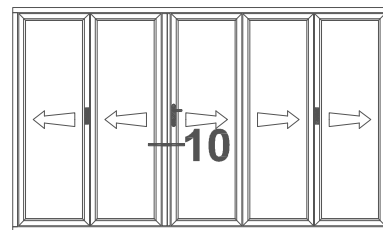

AG65 - Aluminium / GlassEdge Folding Sliding Door System

General Arrangement Drawings - Outward Opening

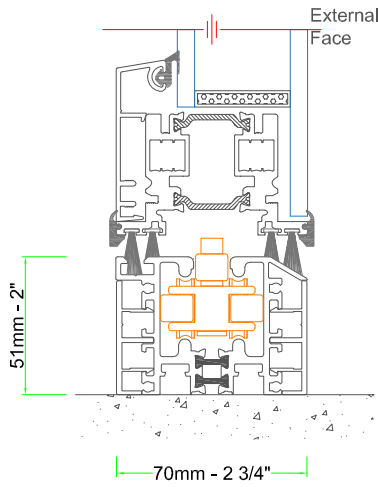

Raised Track

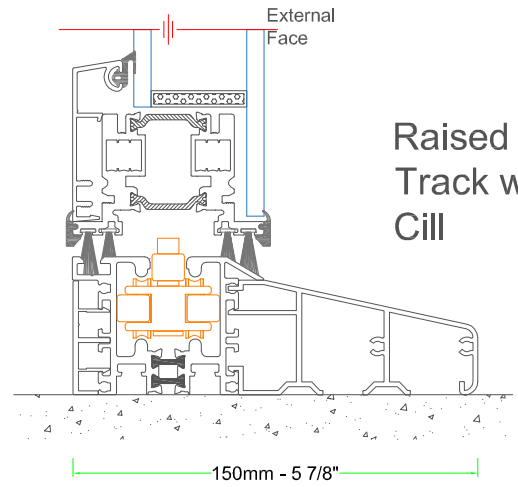

Raised Track with Cill

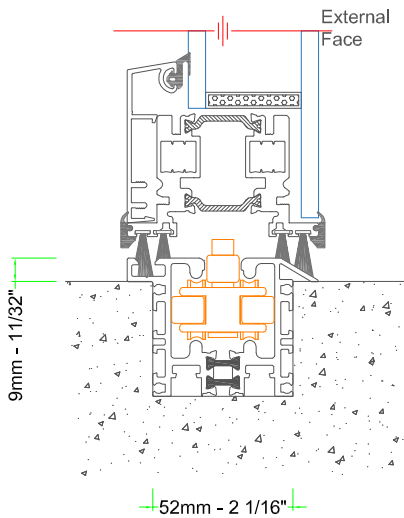

Flush Track

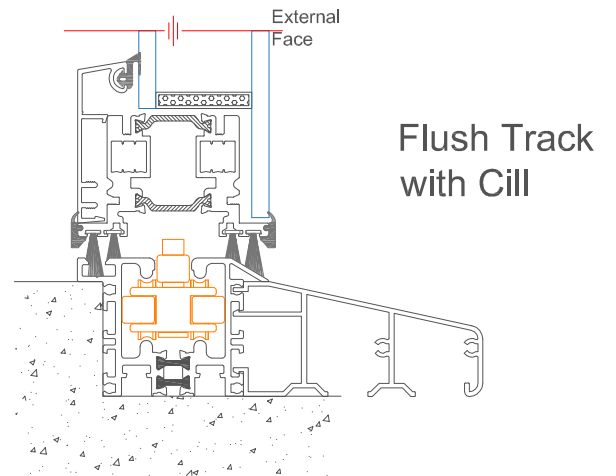

Flush Track with Cill

Optional threshold rebate available for all threshold types

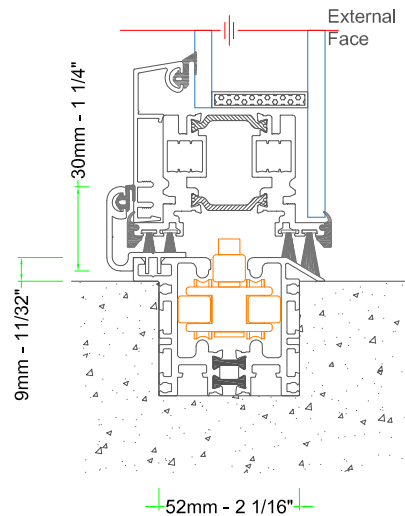

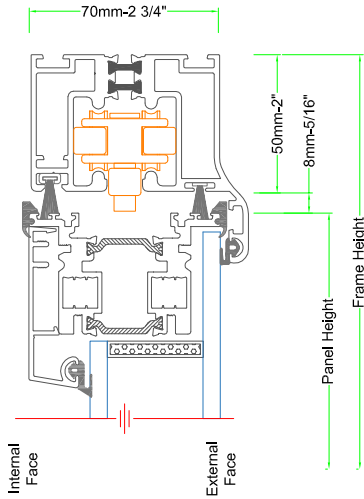

Section 1:
Top Track

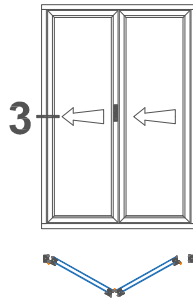
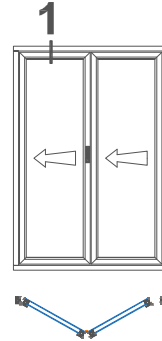

Section 3:
Jamb

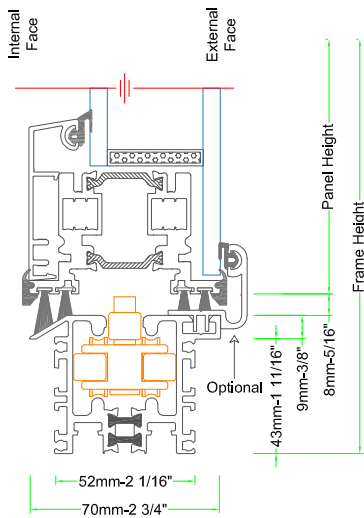
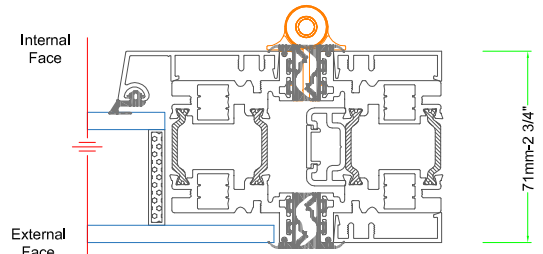

Section 2:
Bottom Track

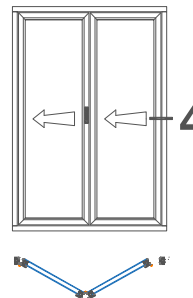
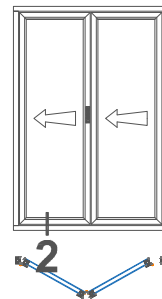

Section 4:
Jamb with Roller Assembly

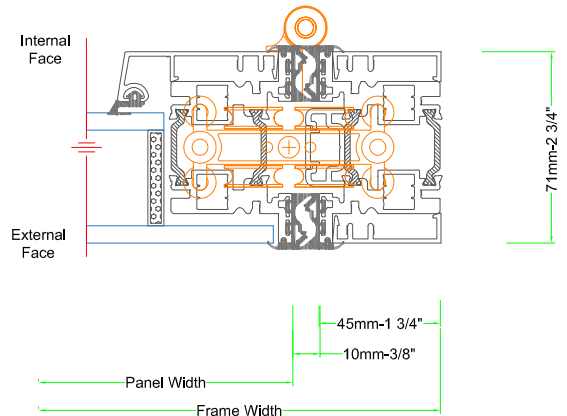
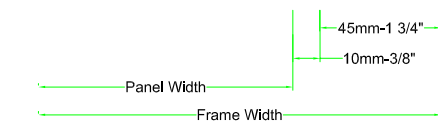

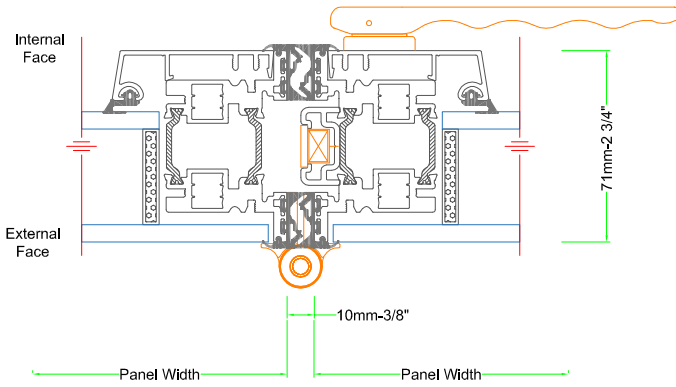

Section 5:
Locking folding panels, with Flat Handle

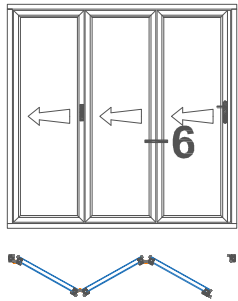
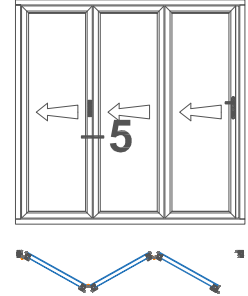

Section 6:
Non-locking folding panels and roller assembly

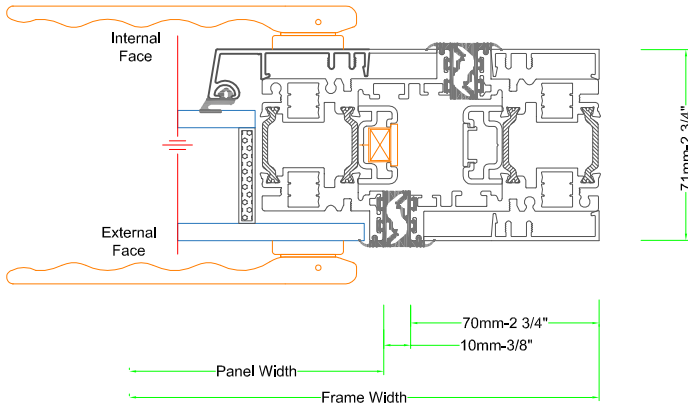
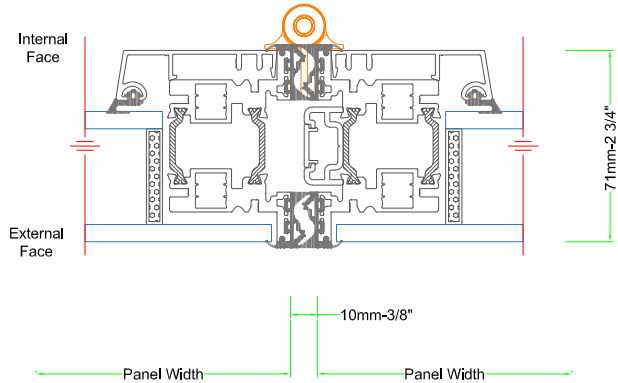

Section 7:
Swing panel and jamb with closing rebates

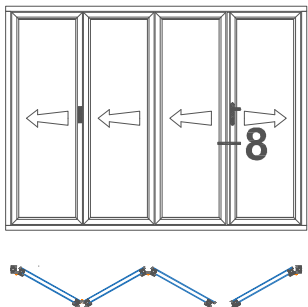
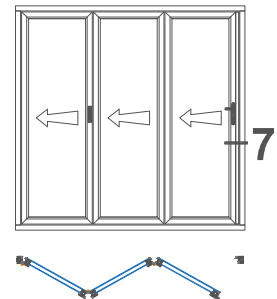

Section 8:
Swing panel and slave panel with closing rebates

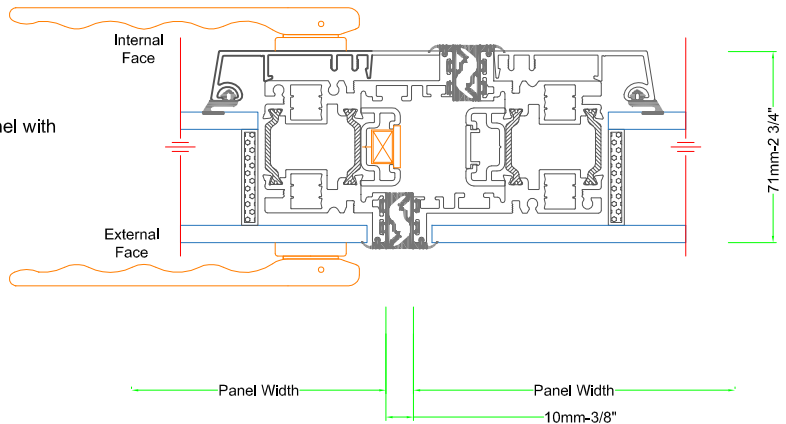

AG65 - Aluminium / GlassEdge Folding Sliding Door System General Arrangement Drawings - Inward Opening

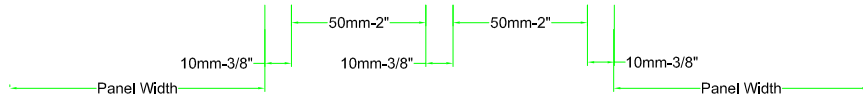
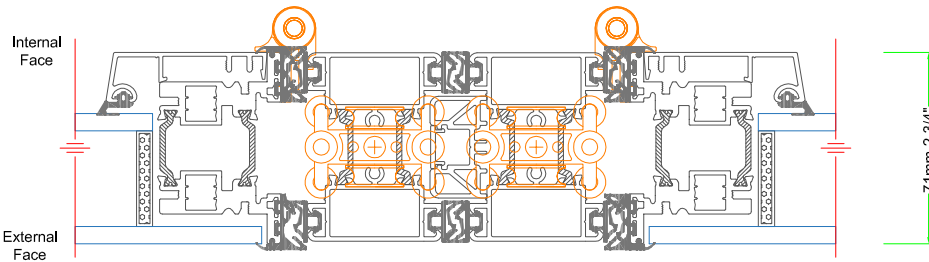

Section 9:
Meeting sliding mullions with
roller assemblies

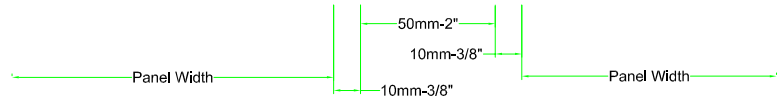
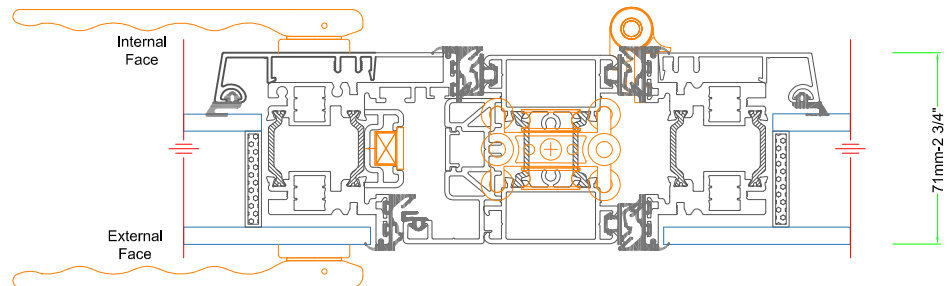
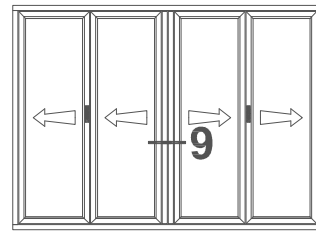

Section 10:
Sliding mullion and swing panel
with closing rebates and roller
assembly

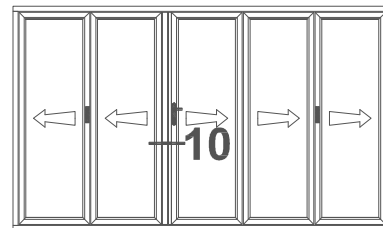

AG65 - Aluminium / GlassEdge Folding Sliding Door System

General Arrangement Drawings - Inward Opening

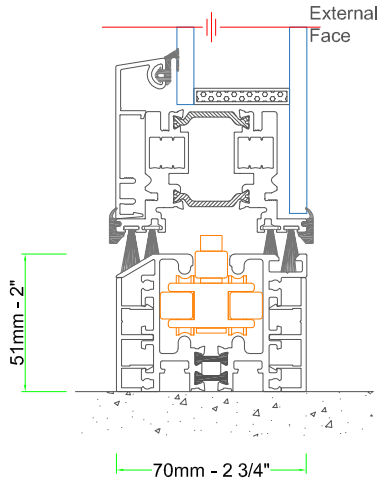

Raised Track

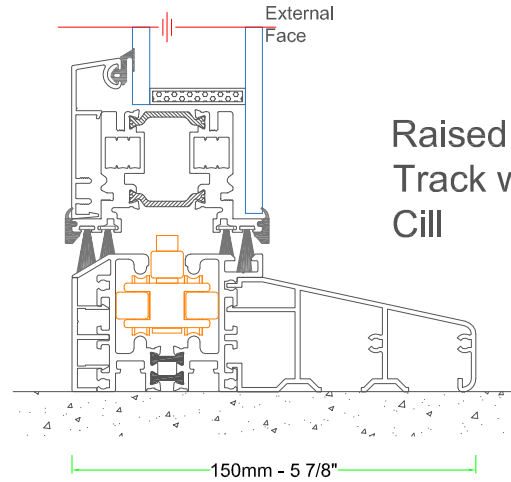

Raised Track with Cill

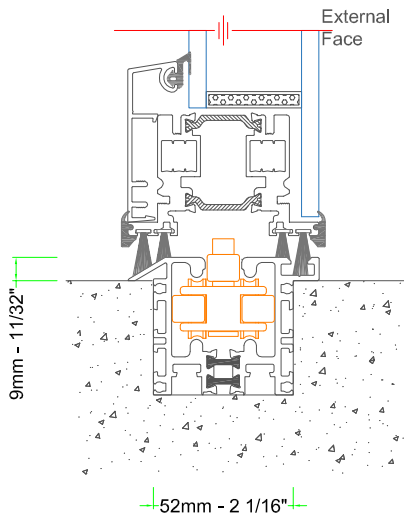

Flush Track

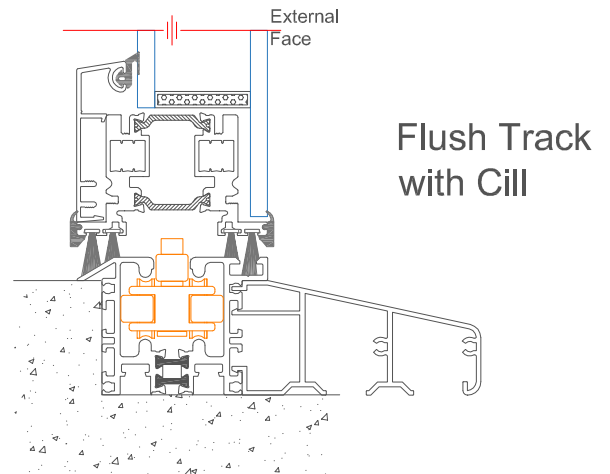

Flush Track with Cill

Optional threshold rebate available for all threshold types

